

## Naos Raptor 40A Non-Isolated Power Modules

### 5 – 13.8Vdc input; 0.6Vdc to 5.0Vdc Output; 40A Output Current

TUNABLE  
LOOP™  
A LINEAGE POWER TRADEMARK



### RoHS Compliant Applications

- Distributed power architectures
- Intermediate bus voltage applications
- Telecommunications equipment
- Servers and storage applications
- Networking equipment

### Features

- Compliant to RoHS EU Directive 2002/95/EC (Z versions)
- Compatible in a Pb-free or SnPb wave-soldering environment (Z versions)
- Wide input voltage range (5Vdc-13.8Vdc)
- Output voltage programmable from 0.6Vdc to 5.0Vdc via external resistor
- Tunable Loop™ to optimize dynamic output voltage response
- Fixed switching frequency
- Output overcurrent protection (non-latching)
- Over temperature protection
- Remote On/Off
- Remote Sense
- Power Good Signal
- Over voltage protection – Hiccup Mode
- Small size:
  - 36.8 mm x 27.9 mm x 10.7 mm
  - (1.45 in. x 1.10 in. x 0.42 in)
- Wide operating temperature range (0°C to 70°C)
- UL\* 60950 Recognized, CSA† C22.2 No. 60950-00 Certified, and VDE‡ 0805 (EN60950-1 3<sup>rd</sup> edition) Licensed
- ISO\*\* 9001 and ISO 14001 certified manufacturing facilities

### Description

The Naos Raptor 40A SIP power modules are non-isolated dc-dc converters in an industry standard package that can deliver up to 40A of output current with a full load efficiency of 92% at 3.3Vdc output voltage ( $V_{IN} = 12Vdc$ ). These modules operate over a wide range of input voltage ( $V_{IN} = 5Vdc-13.8Vdc$ ) and provide a precisely regulated output voltage from 0.6dc to 5.0Vdc, programmable via an external resistor. Features include remote On/Off, adjustable output voltage, over current and over temperature protection. A new feature, the Tunable Loop™, allows the user to optimize the dynamic response of the converter to match the load.

\* UL is a registered trademark of Underwriters Laboratories, Inc.  
† CSA is a registered trademark of Canadian Standards Association.  
‡ VDE is a trademark of Verband Deutscher Elektrotechniker e.V.  
\*\* ISO is a registered trademark of the International Organization of Standards

## Absolute Maximum Ratings

Stresses in excess of the absolute maximum ratings can cause permanent damage to the device. These are absolute stress ratings only, functional operation of the device is not implied at these or any other conditions in excess of those given in the operations sections of the data sheet. Exposure to absolute maximum ratings for extended periods can adversely affect the device reliability.

Parameter	Device	Symbol	Min	Max	Unit
Input Voltage Continuous	All	$V_{IN}$	-0.3	15	Vdc
Operating Ambient Temperature (see Thermal Considerations section)	All	$T_A$	0	70	°C
Storage Temperature	All	$T_{stg}$	-55	125	°C

## Electrical Specifications

Unless otherwise indicated, specifications apply over all operating input voltage, resistive load, and temperature conditions.

Parameter	Device	Symbol	Min	Typ	Max	Unit
Operating Input Voltage	All	$V_{IN}$	5		13.8	Vdc
Maximum Input Current ( $V_{IN} = V_{IN, min}$ to $V_{IN, max}$ ; $I_O = I_{O, max}$ ; $V_{O, set} = 3.3Vdc$ )	All	$I_{IN, max}$			30	Adc
Input No Load Current ( $V_{IN} = 12Vdc$ , $I_O = 0$ , module ON)	$V_{O, set} = 0.6 Vdc$	$I_{IN, No load}$		165		mA
	$V_{O, set} = 5.0Vdc$	$I_{IN, No load}$		360		mA
Input Stand-by Current ( $V_{IN} = 12Vdc$ , module disabled)	All	$I_{IN, stand-by}$		23		mA
Inrush Transient	All	$I^2t$			1	A <sup>2</sup> s
Input Reflected Ripple Current, peak-to-peak (5Hz to 20MHz, 1μH source impedance; $V_{IN, min}$ to $V_{IN, max}$ , $I_O = I_{O, max}$ ; See Test configuration section)	All			130		mAp-p
Input Ripple Rejection (120Hz)	All			50		dB

### CAUTION: This power module is not internally fused. An input line fuse must always be used.

This power module can be used in a wide variety of applications, ranging from simple standalone operation to being part of a complex power architecture. To preserve maximum flexibility, internal fusing is not included, however, to achieve maximum safety and system protection, always use an input line fuse. The safety agencies require a fast-acting fuse with a maximum rating of 30A (see Safety Considerations section). Based on the information provided in this data sheet on inrush energy and maximum dc input current, the same type of fuse with a lower rating can be used. Refer to the fuse manufacturer's data sheet for further information.

Electrical Specifications (continued)

Parameter	Device	Symbol	Min	Typ	Max	Unit
Output Voltage Set-point ( $V_{IN}=V_{IN, min}$ , $I_O=I_{O, max}$ , $T_A=25^\circ\text{C}$ ) $V_{O, SET} \geq 1.2\text{Vdc}$ $V_{O, SET} < 1.2\text{Vdc}$	All All	$V_{O, set}$ $V_{O, set}$	-0.8 -10	— —	+0.8 +10	% $V_{O, set}$ mV
Output Voltage (Over all operating input voltage, resistive load, and temperature conditions until end of life)	All	$V_{O, set}$	-1.1%	—	+1.1%	% $V_{O, set}$
Adjustment Range Selected by an external resistor	All	$V_O$	0.6	—	5.0	Vdc
Output Regulation (for $V_O \geq 2.5\text{V}$ ) Input range1 (5V – 9V); range2 (9V – 13.8V) Line (Range1, range2) Load ( $I_O=I_{O, min}$ to $I_{O, max}$ ) Line & Load Output Regulation (for $V_O < 2.5\text{V}$ ) Input range1 (5V – 9V); range2 (9V – 13.8V) Line (Range1, range2) Load ( $I_O=I_{O, min}$ to $I_{O, max}$ ) Line & Load	All All All All All All All	— — — — — — —	— — — — — — —	— — — — — — —	0.3 0.6 0.8 9 12 15	% $V_{O, set}$ % $V_{O, set}$ % $V_{O, set}$ mV mV mV
Output Ripple and Noise on nominal output ( $V_{IN}=V_{IN, nom}$ and $I_O=I_{O, min}$ to $I_{O, max}$ , $C_{out} = 0\mu\text{F}$ ) Peak-to-Peak (5Hz to 20MHz bandwidth) Peak-to-Peak (5Hz to 20MHz bandwidth) Peak-to-Peak (5Hz to 20MHz bandwidth) Peak-to-Peak (5Hz to 20MHz bandwidth) Peak-to-Peak (5Hz to 20MHz bandwidth) Peak-to-Peak (5Hz to 20MHz bandwidth)	$V_O = 0.6\text{V}$ $V_O = 1\text{V}$ $V_O = 1.5\text{V}$ $V_O = 2.5\text{V}$ $V_O = 3.3\text{V}$ $V_O = 5.0\text{V}$	— — — — — —	— — — — — —	— — — — — —	30 30 40 40 60 60	mV <sub>pk-pk</sub> mV <sub>pk-pk</sub> mV <sub>pk-pk</sub> mV <sub>pk-pk</sub> mV <sub>pk-pk</sub> mV <sub>pk-pk</sub>
External Capacitance <sup>1</sup> Without the Tunable Loop™ ESR $\geq 1\text{ m}\Omega$ With the Tunable Loop™ ESR $\geq 0.15\text{ m}\Omega$ ESR $\geq 10\text{ m}\Omega$	All All All	$C_{O, max}$ $C_{O, max}$ $C_{O, max}$	— — —	— — —	1000 1500 10000	$\mu\text{F}$ $\mu\text{F}$ $\mu\text{F}$
Output Current	All	$I_O$	0	—	40	Adc
Output Current Limit Inception (Hiccup Mode )	All	$I_{O, lim}$	103	130	180	% $I_O$
Output Short-Circuit Current ( $V_O \leq 250\text{mV}$ ) ( Hiccup Mode )	All	$I_{O, s/c}$	—	5.7	—	Arms
Efficiency $V_{IN} = V_{IN, nom}$ , $T_A = 25^\circ\text{C}$ $I_O = I_{O, max}$ , $V_O = V_{O, set}$	$V_{O, set} = 0.6\text{Vdc}$ $V_{O, set} = 1.2\text{Vdc}$ $V_{O, set} = 1.8\text{Vdc}$ $V_{O, set} = 2.5\text{Vdc}$ $V_{O, set} = 3.3\text{Vdc}$ $V_{O, set} = 5.0\text{Vdc}$	$\eta$ $\eta$ $\eta$ $\eta$ $\eta$ $\eta$	— — — — — —	— — — — — —	70.9 82.3 86.8 89.5 91.4 93.7	% % % % % %
Switching Frequency	All	$f_{sw}$	—	500	—	kHz

<sup>1</sup> External capacitors may require using the new Tunable Loop™ feature to ensure that the module is stable as well as getting the best transient response. See the Tunable Loop™ section for details.

## General Specifications

Parameter	Min	Typ	Max	Unit
Calculated MTBF ( $V_{IN}=12V$ , $V_O=5Vdc$ , $I_O=0.8I_{O,max}$ , $T_A=40^\circ C$ ) Per Telcordia Issue 2 Method 1 Case 3		4,107,921		Hours
Weight	—	17.5 (0.617)	—	g (oz.)

## Feature Specifications

Unless otherwise indicated, specifications apply over all operating input voltage, resistive load, and temperature conditions. See Feature Descriptions for additional information.

Parameter	Device	Symbol	Min	Typ	Max	Unit
On/Off Signal Interface ( $V_{IN}=V_{IN,min}$ to $V_{IN,max}$ ; open collector or equivalent, Signal referenced to GND) Logic High (On/Off pin open – Module ON)						
Input High Current	All	$I_{IH}$	0.5	—	3.3	mA
Input High Voltage	All	$V_{IH}$	1.0	—	5.5	V
Logic Low (Module OFF)						
Input Low Current	All	$I_{IL}$	—	—	200	$\mu A$
Input Low Voltage	All	$V_{IL}$	-0.3	—	0.4	V
PwGood (Power Good) Signal Interface Open Collector/Drain PwGood = High = Power Good PwGood = Low = Power Not Good						
Logic level low voltage			0		0.4	V
Logic level high voltage			2.4		5.25	V
Sink Current, PwGood = low					4	mA
Turn-On Delay and Rise Times ( $V_{IN}=V_{IN,nom}$ , $I_O=I_{O,max}$ , $V_O$ to within $\pm 1\%$ of steady state)						
Case 1: On/Off input is enabled and then input power is applied (delay from instant at which $V_{IN} = V_{IN,min}$ until $V_O = 10\%$ of $V_{O,set}$ )	All	Tdelay			3	msec
Case 2: Input power is applied for at least one second and then the On/Off input is enabled (delay from instant at which On/Off is enabled until $V_O = 10\%$ of $V_{O,set}$ )	All	Tdelay			1.2	msec
Output voltage Rise time (time for $V_O$ to rise from 10% of $V_{O,set}$ to 90% of $V_{O,set}$ )	All	Trise			3	msec
Output voltage overshoot $I_O = I_{O,max}$ ; $V_{IN,min} - V_{IN,max}$ ; $T_A = 25^\circ C$					0.5	% $V_{O,set}$
Remote Sense Range	All		—	—	0.5	V
Over Temperature Protection (See Thermal Considerations section)	All	$T_{ref}$		127		$^\circ C$
Input Undervoltage Lockout						
Turn-on Threshold	All			4.4	4.8	Vdc
Turn-off Threshold	All			4.2		Vdc
Overshoot Protection (Hiccup Mode)	All		120	125	130	$V_{O,set}, \%$

### Characteristic Curves

The following figures provide typical characteristics for the Naos Raptor 40A modules at 0.6V<sub>out</sub> and 25°C.

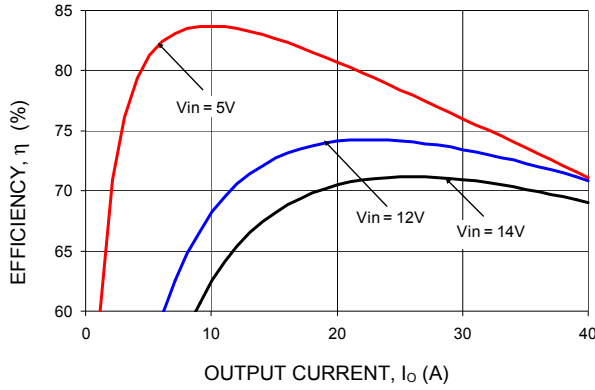

Figure 1. Converter Efficiency versus Output Current.

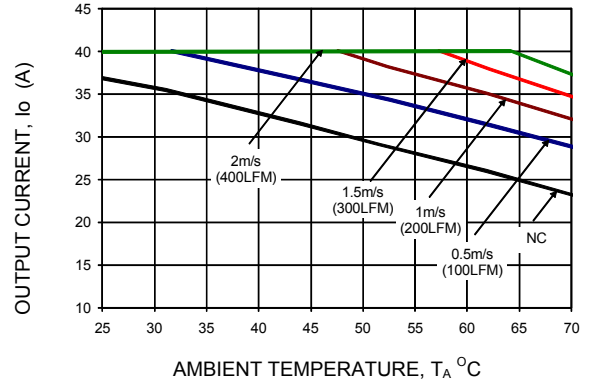

Figure 2. Derating Output Current versus Ambient Temperature and Airflow.

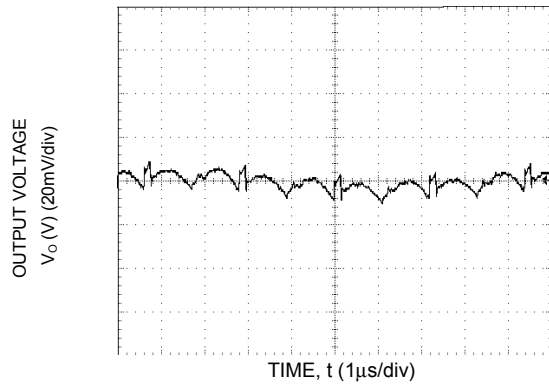

Figure 3. Typical output ripple and noise ( $V_{IN} = 12V$ ,  $I_o = I_{o,max}$ ).

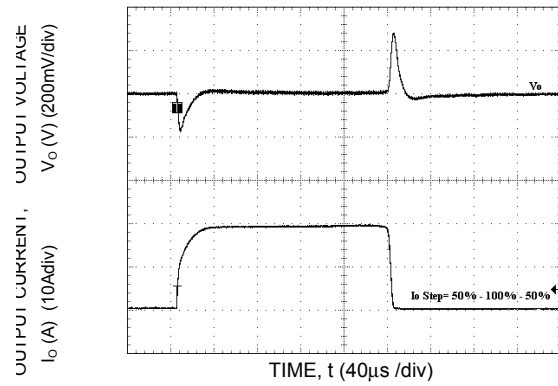

Figure 4. Transient Response to Dynamic Load Change from 0% to 50% to 100% with  $V_{IN}=12V$ .

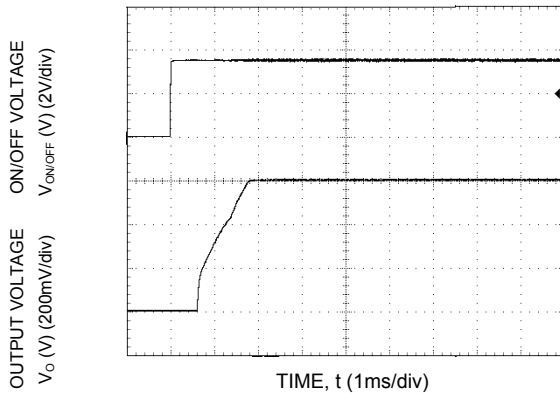

Figure 5. Typical Start-up Using On/Off Voltage ( $I_o = I_{o,max}$ ).

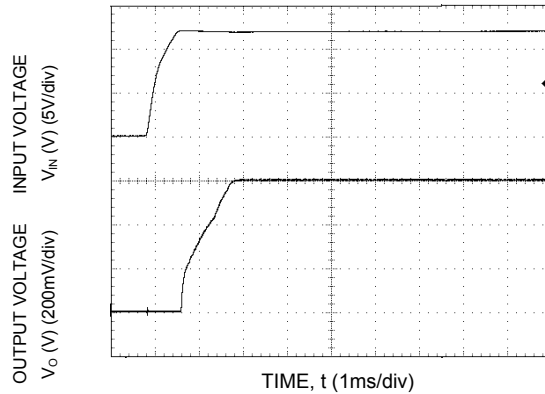

Figure 6. Typical Start-up Using Input Voltage ( $V_{IN} = 9V$ ,  $I_o = I_{o,max}$ ).

### Characteristic Curves (continued)

The following figures provide typical characteristics for the Naos Raptor 40A modules at 1.2V<sub>out</sub> and 25°C.

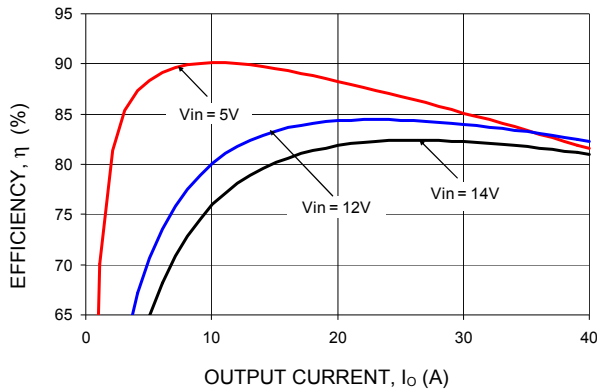

Figure 7. Converter Efficiency versus Output Current.

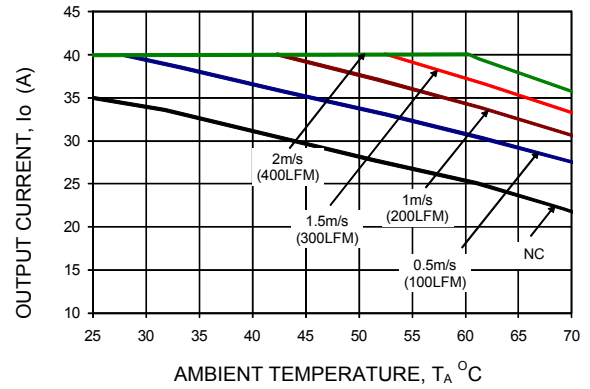

Figure 8. Derating Output Current versus Ambient Temperature and Airflow.

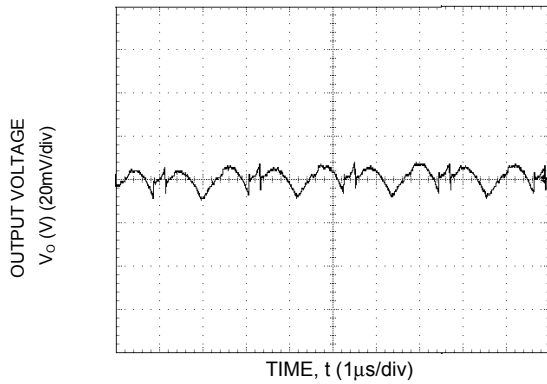

Figure 9. Typical output ripple and noise ( $V_{IN} = 12V$ ,  $I_o = I_{o,max}$ ).

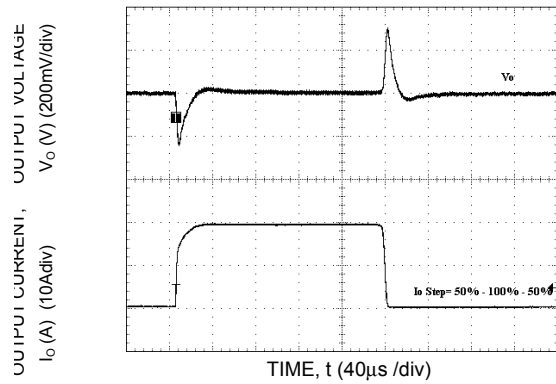

Figure 10. Transient Response to Dynamic Load Change from 0% to 50% to 100% to 50% to 0% with  $V_{IN}=12V$ .

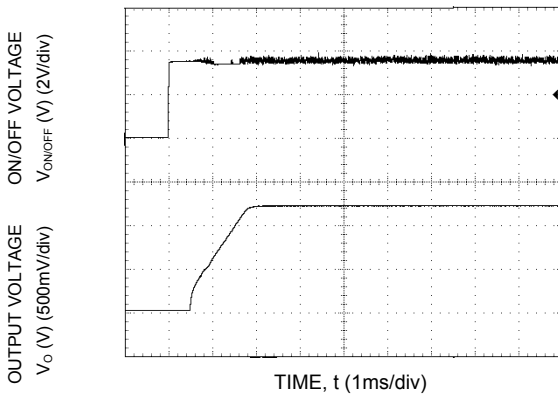

Figure 11. Typical Start-up Using On/Off Voltage ( $I_o = I_{o,max}$ ).

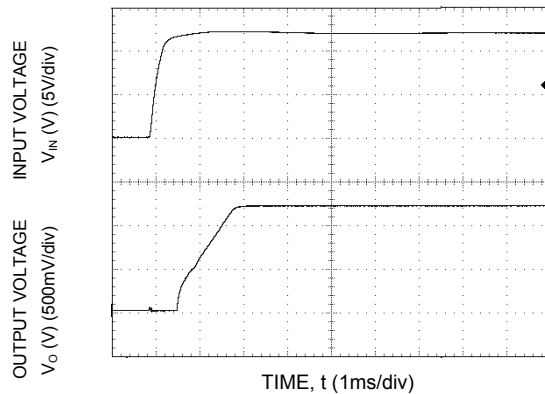

Figure 12. Typical Start-up Using Input Voltage ( $V_{IN} = 12V$ ,  $I_o = I_{o,max}$ ).

### Characteristic Curves (continued)

The following figures provide typical characteristics for the Naos Raptor 40A modules at 1.8Vout and at 25°C.

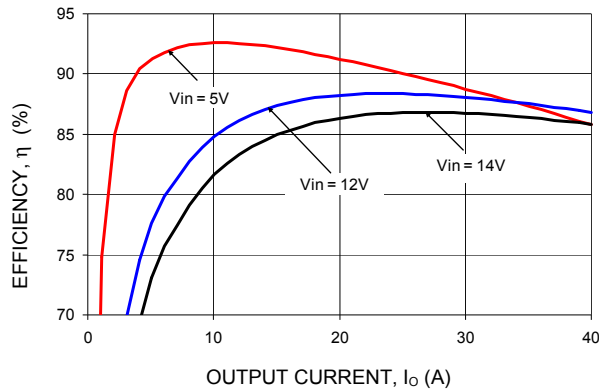

Figure 13. Converter Efficiency versus Output Current.

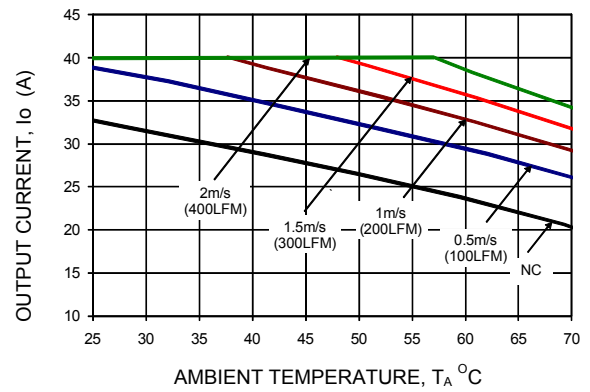

Figure 14. Derating Output Current versus Ambient Temperature and Airflow.

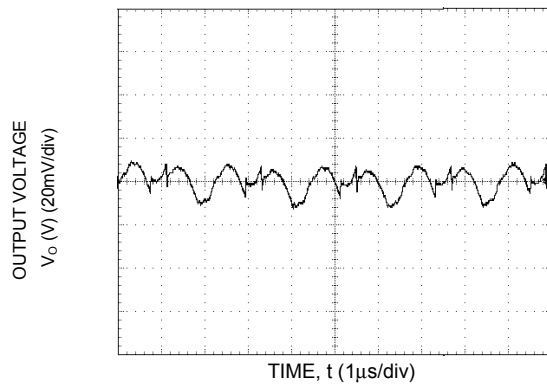

Figure 15. Typical output ripple and noise ( $V_{IN} = 12V$ ,  $I_o = I_{o,max}$ ).

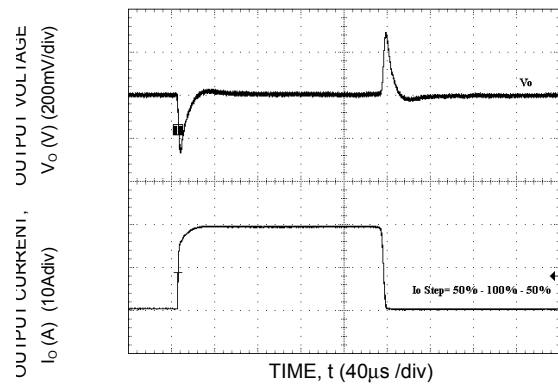

Figure 16. Transient Response to Dynamic Load Change from 0% to 50% to 100% to 0% with  $V_{IN}=12V$ .

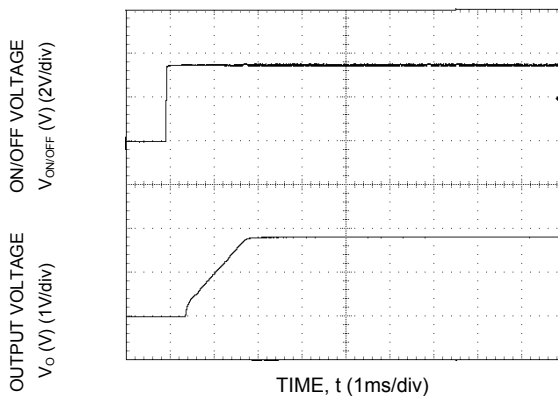

Figure 17. Typical Start-up Using On/Off Voltage ( $I_o = I_{o,max}$ ).

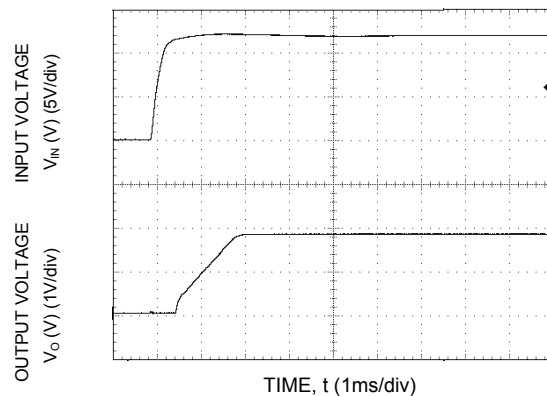

Figure 18. Typical Start-up Using Input Voltage ( $V_{IN} = 12V$ ,  $I_o = I_{o,max}$ ).

### Characteristic Curves (continued)

The following figures provide thermal derating curves for Naos Raptor 40A modules at 2.5Vout and 25°C.

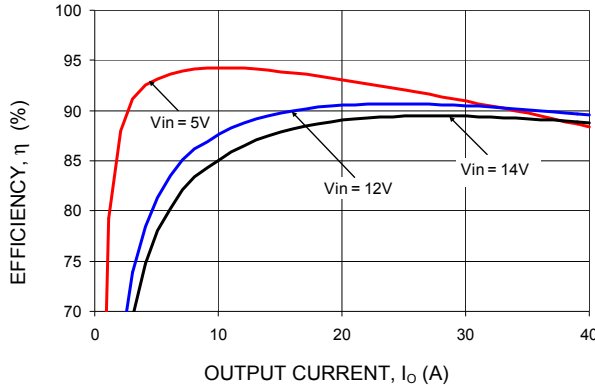

Figure 19. Converter Efficiency versus Output Current.

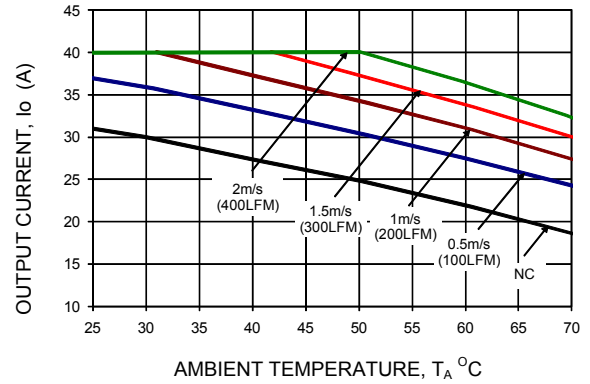

Figure 20. Derating Output Current versus Ambient Temperature and Airflow.

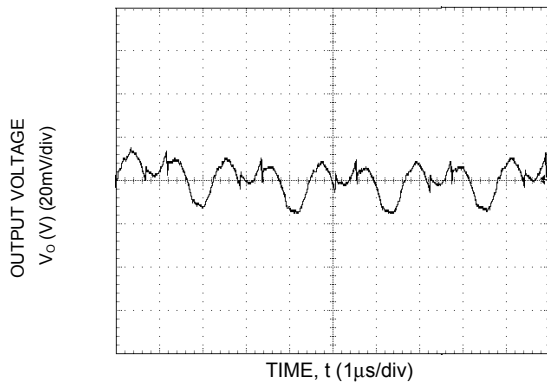

Figure 21. Typical output ripple and noise ( $V_{IN} = 12V$ ,  $I_o = I_{o,max}$ ).

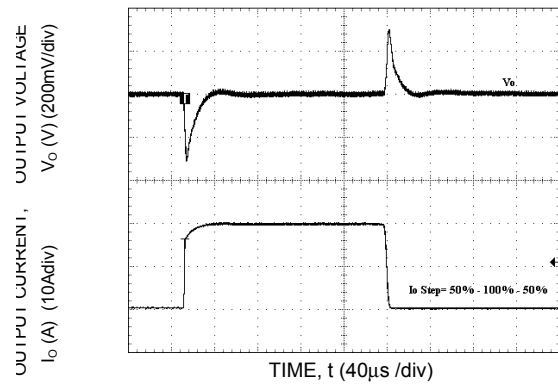

Figure 22. Transient Response to Dynamic Load Change from 0% to 50% to 100% to 50% with  $V_{IN}=12V$ .

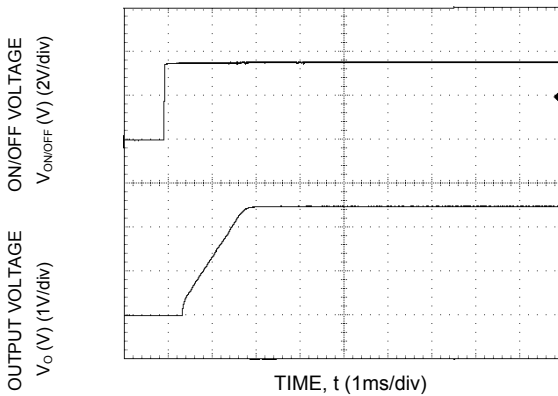

Figure 23. Typical Start-up Using On/Off Voltage ( $I_o = I_{o,max}$ ).

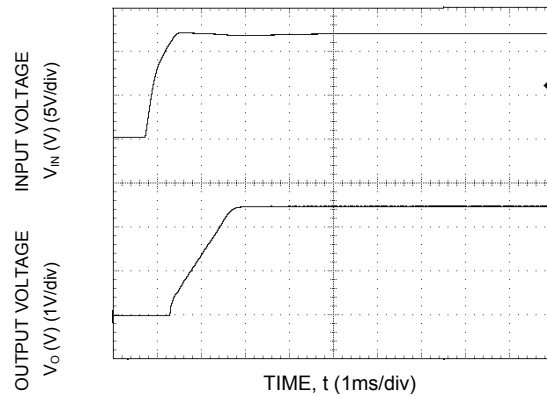

Figure 24. Typical Start-up Using Input Voltage ( $V_{IN} = 12V$ ,  $I_o = I_{o,max}$ ).



Characteristic Curves (continued)

The following figures provide thermal derating curves for Naos Raptor 40A modules at 3.3Vout and 25°C.

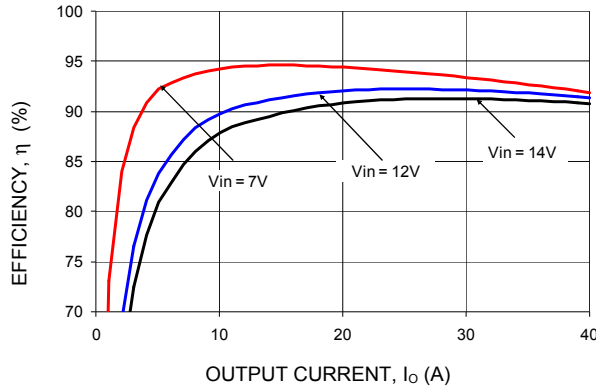

Figure 25. Converter Efficiency versus Output Current.

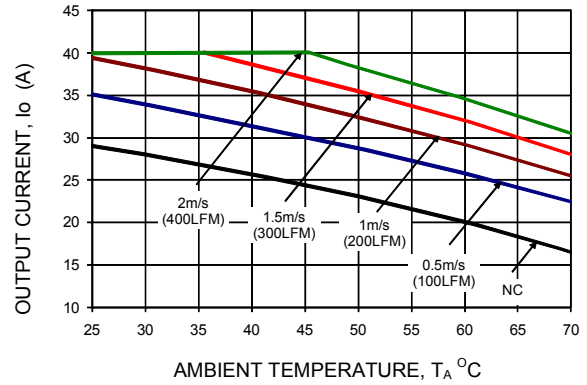

Figure 26. Derating Output Current versus Ambient Temperature and Airflow.

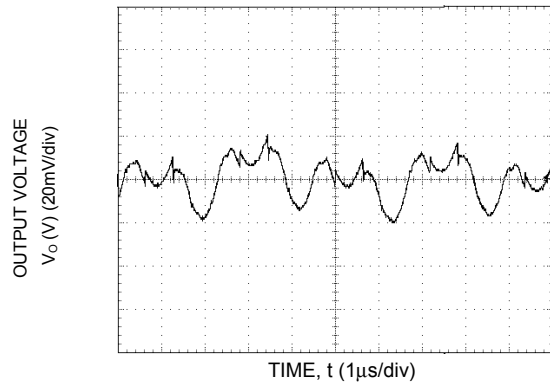

Figure 27. Typical output ripple and noise ( $V_{IN} = 12V$ ,  $I_o = I_{o,max}$ ).

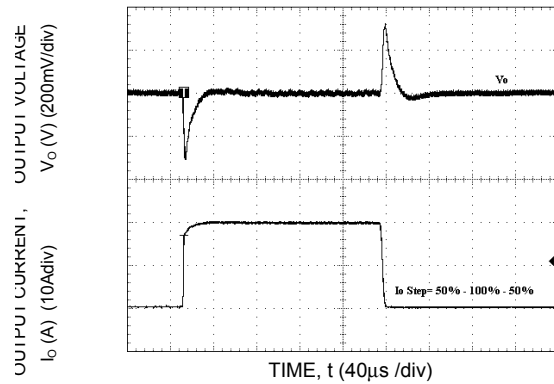

Figure 28. Transient Response to Dynamic Load Change from 0% to 50% to 100% to 50% with  $V_{IN}=12V$ .

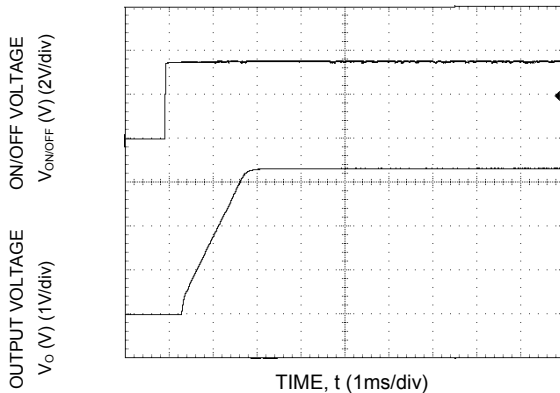

Figure 29. Typical Start-up Using On/Off Voltage ( $I_o = I_{o,max}$ ).

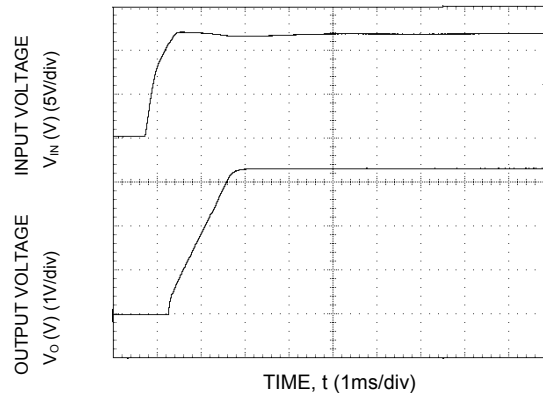

Figure 30. Typical Start-up Using Input Voltage ( $V_{IN} = 12V$ ,  $I_o = I_{o,max}$ ).

Characteristic Curves (continued)

The following figures provide thermal derating curves for Naos Raptor 40A modules at 5Vout and 25°C.

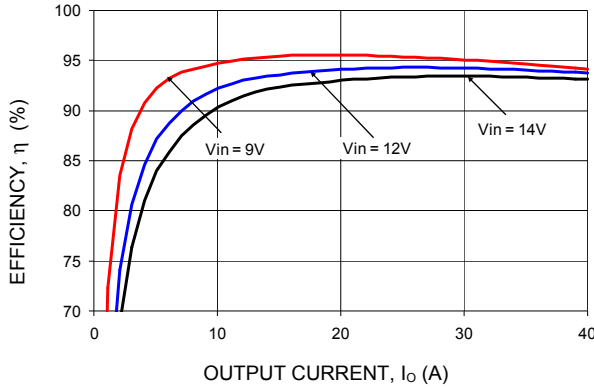

Figure 31. Converter Efficiency versus Output Current.

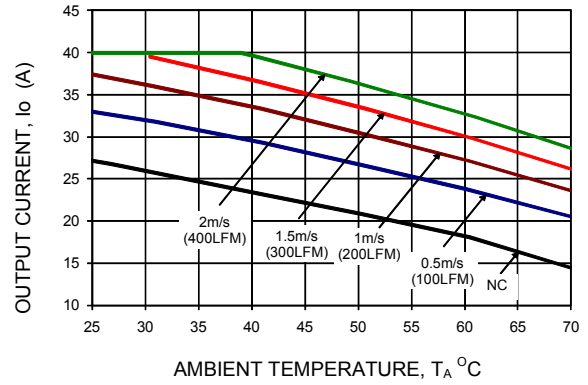

Figure 32. Derating Output Current versus Ambient Temperature and Airflow.

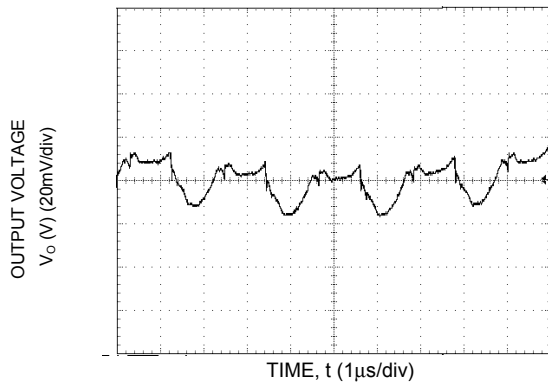

Figure 33. Typical output ripple and noise ( $V_{IN} = 12V$ ,  $I_o = I_{o,max}$ ).

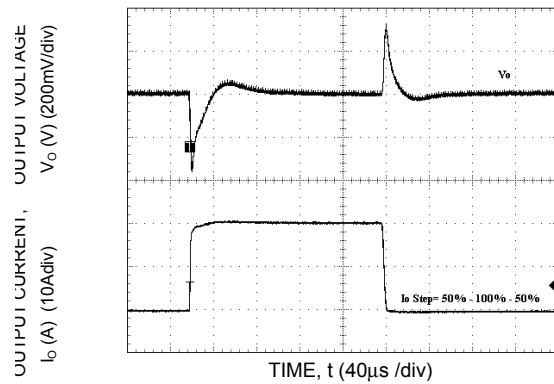

Figure 34. Transient Response to Dynamic Load Change from 0% to 50% to 0% with  $V_{IN}=12V$ .

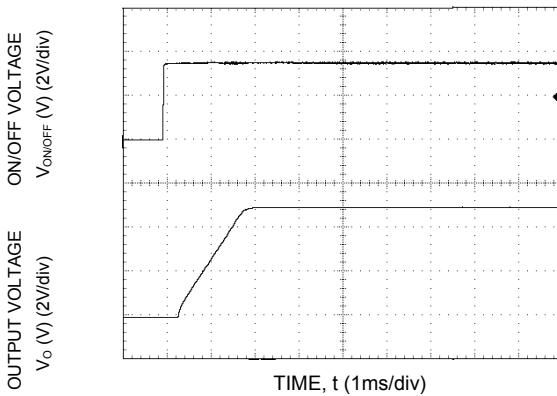

Figure 35. Typical Start-up Using On/Off Voltage ( $I_o = I_{o,max}$ ).

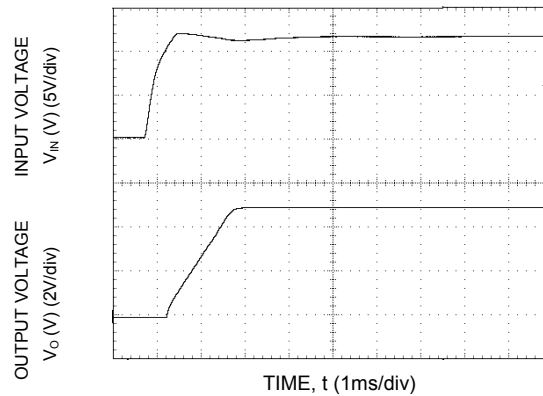
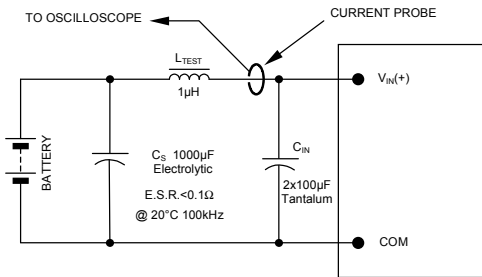

Figure 36. Typical Start-up Using Input Voltage ( $V_{IN} = 12V$ ,  $I_o = I_{o,max}$ ).

## Test Configurations



NOTE: Measure input reflected ripple current with a simulated source inductance ( $L_{TEST}$ ) of 1µH. Capacitor  $C_S$  offsets possible battery impedance. Measure current as shown above.

Figure 37. Input Reflected Ripple Current Test Setup.

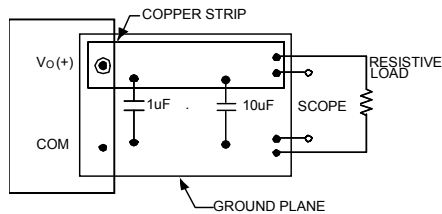

NOTE: All voltage measurements to be taken at the module terminals, as shown above. If sockets are used then Kelvin connections are required at the module terminals to avoid measurement errors due to socket contact resistance.

Figure 38. Output Ripple and Noise Test Setup.

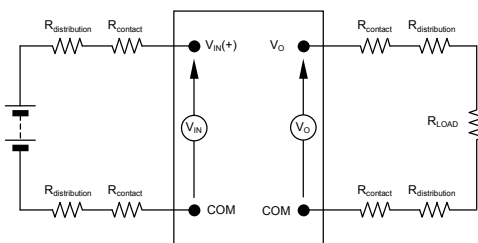

NOTE: All voltage measurements to be taken at the module terminals, as shown above. If sockets are used then Kelvin connections are required at the module terminals to avoid measurement errors due to socket contact resistance.

Figure 39. Output Voltage and Efficiency Test Setup.

$$\text{Efficiency } \eta = \frac{V_O \cdot I_O}{V_{IN} \cdot I_{IN}} \times 100 \%$$

## Design Considerations

### Input Filtering

The Naos Raptor 40A module should be connected to a low-impedance source. A highly inductive source can affect the stability of the module. An input capacitance must be placed directly adjacent to the input pin of the module, to minimize input ripple voltage and ensure module stability.

To minimize input voltage ripple, low-ESR ceramic capacitors are recommended at the input of the module. Figure 40 shows the input ripple voltage for various output voltages at 40A of load current with 1x22 µF or 2x22 µF ceramic capacitors and an input of 12V.

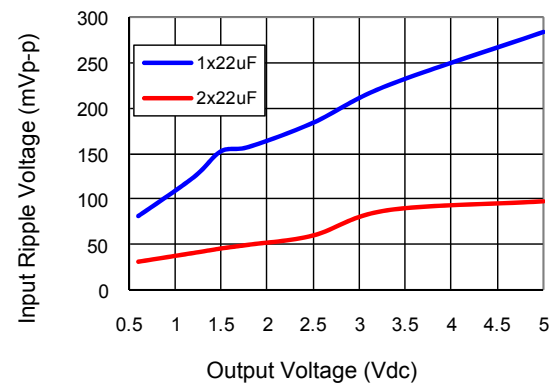

Figure 40. Input ripple voltage for various output voltages with 1x22 µF or 2x22 µF ceramic capacitors at the input (40A load). Input voltage is 12V.

### Output Filtering

The Naos Raptor 40A modules are designed for low output ripple voltage and will meet the maximum output ripple specification with no external capacitors. However, additional output filtering may be required by the system designer for a number of reasons. First, there may be a need to further reduce the output ripple and noise of the module. Second, the dynamic response characteristics may need to be customized to a particular load step change.

To reduce the output ripple and improve the dynamic response to a step load change, additional capacitance at the output can be used. Low ESR ceramic and polymer are recommended to improve the dynamic response of the module. For stable operation of the module, limit the capacitance to less than the maximum output capacitance as specified in the electrical specification table. Optimal performance of the module can be achieved by using the Tunable Loop™ feature described later in this data sheet.

## Safety Considerations

For safety agency approval the power module must be installed in compliance with the spacing and separation requirements of the end-use safety agency standards, i.e., UL 60950-1, CSA C22.2 No. 60950-1-03, and VDE 0850:2001-12 (EN60950-1) Licensed.

For the converter output to be considered meeting the requirements of safety extra-low voltage (SELV), the input must meet SELV requirements. The power module has extra-low voltage (ELV) outputs when all inputs are ELV.

The input to these units is to be provided with a fast-acting fuse with a maximum rating of 30A in the positive input lead.

## Feature Descriptions

### Remote On/Off

The Naos Raptor 40A power modules feature a remote On/Off capability with positive logic. If not using the On/Off pin, leave the pin open (the module will be ON). The On/Off signal ( $V_{On/Off}$ ) is referenced to ground.

During a Logic High on the On/Off pin, the module remains ON. During Logic-Low, the module is turned OFF.

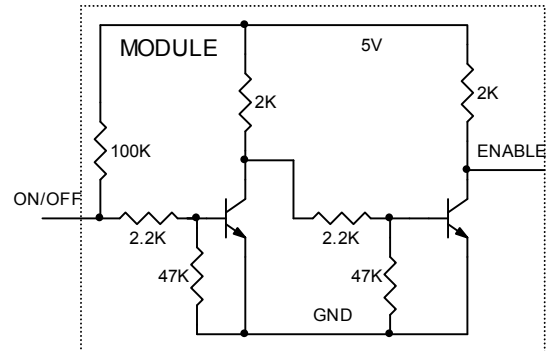

Figure 41. Remote On/Off Implementation.

### Overcurrent Protection

To provide protection in a fault (output overload) condition, the unit is equipped with internal current-limiting circuitry and can endure current limiting continuously. At the point of current-limit inception, the unit enters hiccup mode. The unit operates normally once the output current is brought back into its specified range. The typical average output current during hiccup is 10% of  $I_{o,max}$ .

### Over Temperature Protection

To provide protection in a fault condition, the unit is equipped with a thermal shutdown circuit. The unit will shut down if the overtemperature threshold of 127°C is exceeded at the thermal reference point  $T_{red}$ . The thermal shutdown is not intended as a guarantee that the unit will survive temperatures beyond its rating. Once the unit goes into thermal shutdown, it will then wait to cool before attempting to restart.

### Input Undervoltage Lockout

At input voltages below the input undervoltage lockout limit, module operation is disabled. The module will begin to operate at an input voltage above the undervoltage lockout turn-on threshold.

### Power Good

The Naos Raptor 40A power modules provide a Power Good Status signal that indicates whether or not the power module is functioning properly.

PwGood is a power good signal implemented with an open-collector output to indicate that the output voltage is within the regulation limits of the power module. The PwGood signal will be de-asserted to a low state if any condition such as over-current, or over-voltage occurs which would result in the output voltage going out of range.

### Output Voltage Programming

The output voltage of the Naos Raptor 40A module can be programmed to any voltage from 0.6Vdc to 5.0Vdc by connecting a resistor between the Trim + and Trim - pins of the module. Certain restrictions apply on the output voltage set point depending on the input voltage. These are shown in the Output Voltage vs. Input Voltage Set Point Area plot in Fig. 43. The Lower Limit curve shows that for output voltages of 2.75V and higher, the input needs to be larger than the minimum of 4.5V.

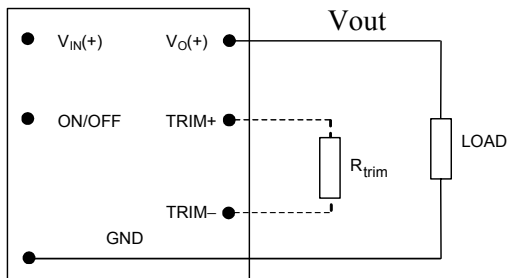

Figure 42. Circuit configuration for programming output voltage using an external resistor.

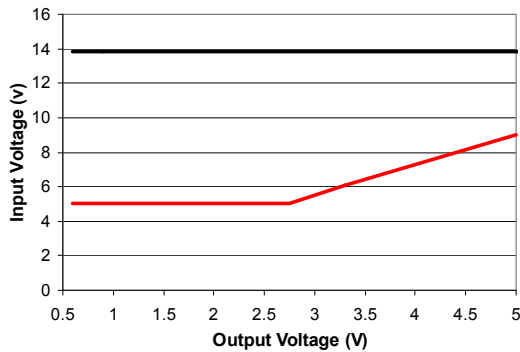

Fig. 43. Output Voltage vs. Input Voltage Set Point Area plot showing limits where the output voltage can be set for different input voltages.

Without an external resistor between Trim + and Trim - pins, the output of the module will be 0.6Vdc. To calculate the value of the trim resistor,  $R_{trim}$  for a desired output voltage, use the following equation:

$$R_{trim} = \frac{1.2}{(V_o - 0.6)} k\Omega$$

$R_{trim}$  is the external resistor in  $k\Omega$

$V_o$  is the desired output voltage

Table 1 provides  $R_{trim}$  values required for some common output voltages.

By using a  $\pm 0.1\%$  tolerance trim resistor with a TC of  $\pm 25$ ppm, a set point tolerance of  $\pm 0.8\%$  can be achieved as specified in the electrical specification. The POL Programming Tool available at [www.lineagepower.com](http://www.lineagepower.com) under the Design Tools section, helps determine the required trim resistor needed for a specific output voltage.

Note:  $V_{in} \geq 180\%$  of  $V_{out}$  at the module output pin.

Table 1

$V_{O, set} (V)$	$R_{trim} (\Omega)$
0.6	Open
1.0	3000
1.2	2000
1.5	1333
1.8	1000
2.5	632
3.3	444
5.0	273

### Monotonic Start-up and Shutdown

The Naos Raptor 40A modules have monotonic start-up and shutdown behavior for any combination of rated input voltage, output current and operating temperature range.

## Feature Descriptions (continued)

### Tunable Loop™

The Naos Raptor 40A modules have a new feature that optimizes transient response of the module called Tunable Loop™. External capacitors are usually added to improve output voltage transient response due to load current changes. Sensitive loads may also require additional output capacitance to reduce output ripple and noise. Adding external capacitance however affects the voltage control loop of the module, typically causing the loop to slow down with sluggish response. Larger values of external capacitance could also cause the module to become unstable.

To use the additional external capacitors in an optimal manner, the Tunable Loop™ feature allows the loop to be tuned externally by connecting a series R-C between the SENSE and TRIM pins of the module, as shown in Fig. 44. This R-C allows the user to externally adjust the voltage loop feedback compensation of the module to match the filter network connected to the output of the module.

Recommended values of  $R_{TUNE}$  and  $C_{TUNE}$  are given in Tables 2 and 3. Table 2 lists recommended values of  $R_{TUNE}$  and  $C_{TUNE}$  in order to meet 2% output voltage deviation limits for some common output voltages in the presence of a 20A to 40A step change (50% of full load), with an input voltage of 12V. Table 3 shows the recommended values of  $R_{TUNE}$  and  $C_{TUNE}$  for different values of ceramic output capacitors up to 1500uF, again for an input voltage of 12V. The value of  $R_{TUNE}$  should never be lower than the values shown in Tables 2 and 3. Please contact your Lineage Power technical representative to obtain more details of this feature as well as for guidelines on how to select the right value of external R-C to tune the module for best transient performance and stable operation for other output capacitance values.

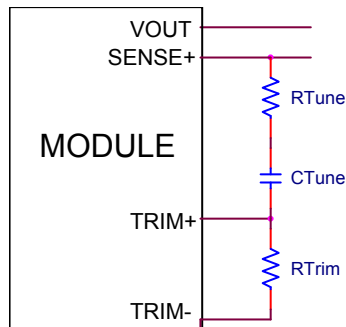

Figure. 44. Circuit diagram showing connection of  $R_{TUNE}$  and  $C_{TUNE}$  to tune the control loop of the module.

Table 2. Recommended values of  $R_{TUNE}$  and  $C_{TUNE}$  to obtain transient deviation of 2% of  $V_{out}$  for a 20A step load with  $V_{in}=12V$ .

$V_{out}$	5V	3.3V	2.5V	1.8V	1.2V	0.69V
$C_{ext}$	6x47 $\mu$ F + 330 $\mu$ F Polymer	2x47 $\mu$ F + 3x330 $\mu$ F Polymer	4x47 $\mu$ F + 4x330 $\mu$ F Polymer	3x47 $\mu$ F + 6x330 $\mu$ F Polymer	2x47 $\mu$ F + 10x330 $\mu$ F Polymer	2x47 $\mu$ F + 22x330 $\mu$ F Polymer
$R_{TUNE}$	75	62	62	39	39	30
$C_{TUNE}$	10nF	18nF	27nF	47nF	68nF	180nF
$\Delta V$	100mV	64mV	50mV	36mV	24mV	12mV

Table 3. General recommended values of  $R_{TUNE}$  and  $C_{TUNE}$  for  $V_{in}=12V$  and various external ceramic capacitor combinations.

$C_{ext}$	2x47 $\mu$ F	4x47 $\mu$ F	10x47 $\mu$ F	20x47 $\mu$ F	30x47 $\mu$ F
$R_{TUNE}$	75	75	39	33	30
$C_{TUNE}$	3300pF	4700pF	8.2nF	12nF	18nF

### Thermal Considerations

Power modules operate in a variety of thermal environments; however sufficient cooling should always be provided to help ensure reliable operation.

Considerations include ambient temperature, airflow, module power dissipation, and the need for increased reliability. A reduction in the operating temperature of the module will result in an increase in reliability. The thermal data presented here is based on physical measurements taken in a wind tunnel. The test set-up is shown in Figure 45. The derating data applies to airflow in either direction of the module's axis.

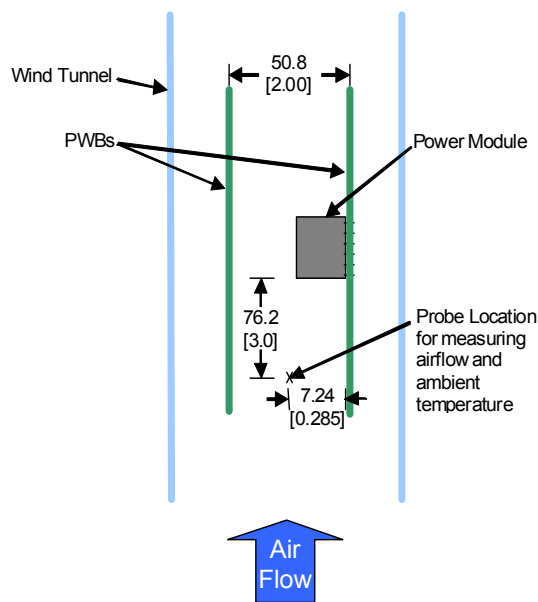

Figure 45. Thermal Test Set-up.

The thermal reference point,  $T_{ref}$  used in the specifications are shown in Figure 46. For reliable operation this temperature should not exceed 122°C. The output power of the module should not exceed the rated power of the module ( $V_{o,set} \times I_{o,max}$ ).

Please refer to the Application Note “Thermal Characterization Process For Open-Frame Board-Mounted Power Modules” for a detailed discussion of thermal aspects including maximum device temperatures.

### Heat Transfer via Convection

Increased airflow over the module enhances the heat transfer via convection. Thermal derating curves showing the maximum output current that can be

delivered at different local ambient temperatures ( $T_A$ ) for airflow conditions ranging from natural convection and up to 2m/s (400 ft./min) are shown in the Characteristics Curves section.

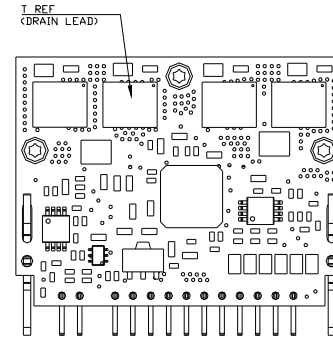

Figure 46. Temperature measurement location  $T_{ref}$ .

### Post solder Cleaning and Drying Considerations

Post solder cleaning is usually the final circuit-board assembly process prior to electrical board testing. The result of inadequate cleaning and drying can affect both the reliability of a power module and the testability of the finished circuit-board assembly. For guidance on appropriate soldering, cleaning and drying procedures, refer to the *Board Mounted Power Modules: Soldering and Cleaning* Application Note.

### Through-Hole Lead-Free Soldering Information

The RoHS-compliant through-hole products use the SAC (Sn/Ag/Cu) Pb-free solder and RoHS-compliant components. They are designed to be processed through single or dual wave soldering machines. The pins have an RoHS-compliant finish that is compatible with both Pb and Pb-free wave soldering processes. A maximum preheat rate of 3°C/s is suggested. The wave preheat process should be such that the temperature of the power module board is kept below 210°C. For Pb solder, the recommended pot temperature is 260°C, while the Pb-free solder pot is 270°C max. Not all RoHS-compliant through-hole products can be processed with paste-through-hole Pb or Pb-free reflow process. If additional information is needed, please consult with your Lineage Power technical representative for more detail.

### Mechanical Outline

Dimensions are in inches and (millimeters).

Tolerances: x.xx in. ± 0.02 in. (x.x mm ± 0.5 mm) [unless otherwise indicated]

x.xxx in ± 0.010 in. (x.xx mm ± 0.25 mm)

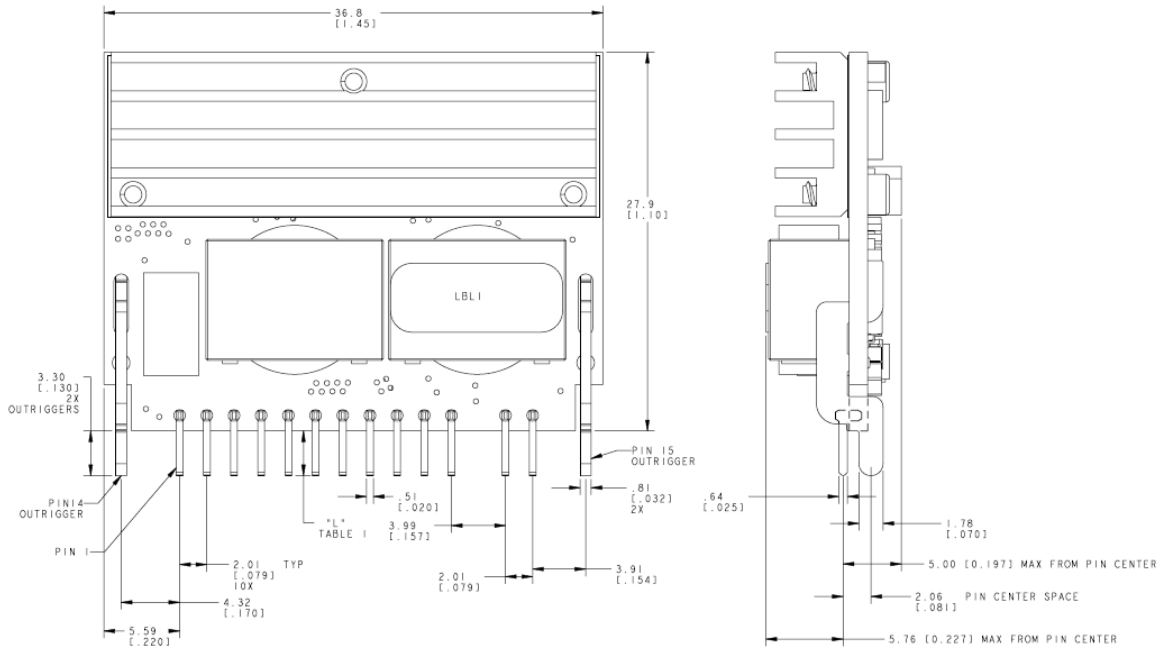

L = 3.3 ± 0.5mm (0.13 ± 0.02 in.)

Front View

Side View

Pin	Function	Pin	Function
1	Vout	8	Trim +
2	Vout	9	PwGood
3	Vout	10	Sense -
4	GND	11	Sense +
5	GND	12	Vin
6	On/Off	13	Vin
7	Trim -	14	GND
		15	GND

Pin Out



### Recommended Pad Layout

Dimensions are in millimeters and (inches).

Tolerances: x.x mm  $\pm$  0.2 mm (x.xx in.  $\pm$  0.01 in.) [unless otherwise indicated]

x.xx mm  $\pm$  0.12 mm (x.xxx in  $\pm$  0.005 in.)

### Recommended Pad Layout

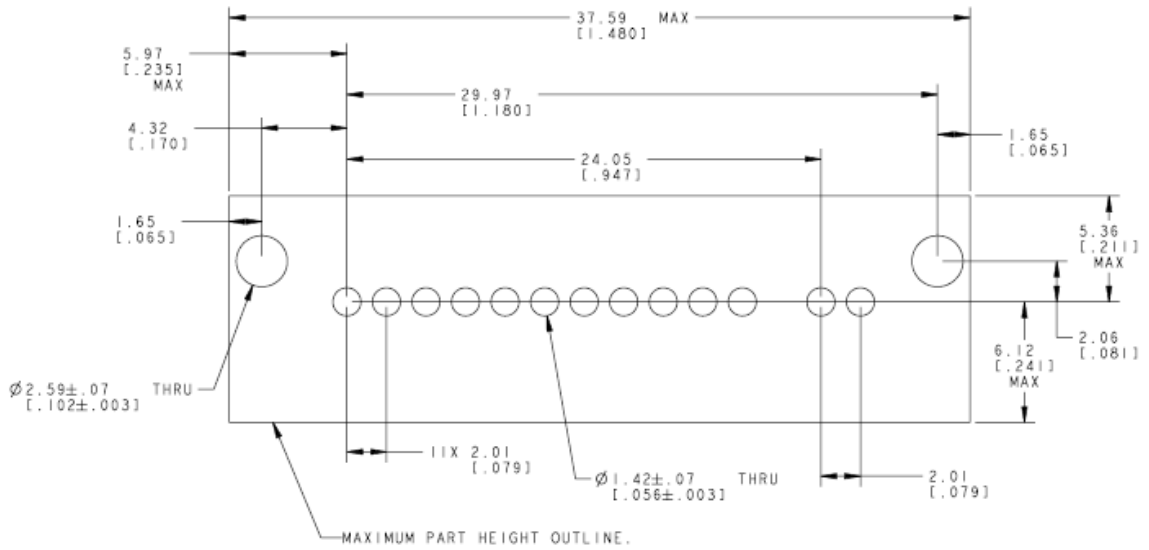

## Ordering Information

Please contact your Lineage Power Sales Representative for pricing, availability and optional features.

**Table 4. Device Codes**

Device Code	Input Voltage Range	Output Voltage	Output Current	On/Off Logic	Connector Type	Comcode
NSR040A0X43Z	5 – 13.8Vdc	0.6 – 5.0Vdc	40 A	Positive	SIP	CC109130928

**Table 5. Coding Scheme**

Series generation	Output Current	Output voltage	Pin Length	On/Off logic	Sense	Default On/Off Condition	ROHS Compliance
NSR	040A0	X		4	3		Z
	040A0=40A	X = programmable output	Blank = Standard 5=5.1mm 6=3.7mm 8=2.8mm	4 = positive No entry = negative	3 = Remote Sense Blank=without	Blank=Standard, ON when unconnected 2=Inverted On/Off	Z = ROHS6



**LINEAGE POWER®**

**World Wide Headquarters**  
Lineage Power Corporation  
601 Shiloh Road, Plano, TX 75074, USA  
**+1-888-LINEAGE(546-3243)**  
(Outside U.S.A.: **+1-972-244-WATT(9288)**)  
**www.lineagepower.com**  
**e-mail: techsupport1@lineagepower.com**

**Asia-Pacific Headquarters**  
Tel: +86.021.54279977\*808

**Europe, Middle-East and Africa Headquarters**  
Tel: +49.89.878067-280

**India Headquarters**  
Tel: +91.80.28411633

Lineage Power reserves the right to make changes to the product(s) or information contained herein without notice. No liability is assumed as a result of their use or application. No rights under any patent accompany the sale of any such product(s) or information.

Lineage Power DC-DC products are protected under various patents. Information on these patents is available at [www.lineagepower.com/patents](http://www.lineagepower.com/patents).

© 2011 Lineage Power Corporation, (Plano, Texas) All International Rights Reserved.