



DRML1 Load Monitoring Module

NOVA22

- Sensing current range from 1.2 to 50 Amps at 600 VAC
- Up to 8 resistive loads can be monitored
- Under & Overcurrent detection
- No Mains Voltage/ Open Load and SSR Short Circuit detection
- Compatible with DIN Rail and Panel Mount SSRs (DR2260DxxV/W & PM2260DxxV)
- Easy installation and removal
- LED status indicator
- IP20 touch-safe housing
- Up to 128 outputs can be connected in parallel

The DRML1 Load Monitoring Module is designed to be plugged on top of any Nova22 Solid State Relay with Contactor configuration (PM22 and DR22 Series with options V or W) to monitor up to 8 heating elements with similar current value, with a total current ranging from 1.2 Amps up to 50 Amps.

The DRML1 module permanently measures the load current and compares it against a pre-set nominal value (TEACH value) which is stored during the installation of the module either by pressing the "Teach-In" pushbutton, placed on the front, or with the external "Teach-In" input.

The alarm output is activated when the module detects an undercurrent of 12.5% below the nominal value, which corresponds to the failure of a single load. The module can also detect other fault conditions, such as: overcurrent (current

exceeding 12.5% of the nominal current), blown fuses (open load), damaged (short circuited) or interrupted SSR, and it can also detect half-wave operation.

The maximum current value (20 Amps or 50 Amps) and an adjustable alarm response delay (0.1 sec, 1 sec or 5 secs) are selectable on the front via the parameter selector switch. The alarm delay avoids fault messages generated by voltage drops.

Malfunctions are indicated by a multicolor LED, which indicates when power is ON and also when the Teach-In function is activated (Blue), when the input signal is ON (Green) and when an alarm condition is activated (Red).

The DRML1 module is ideal for monitoring the correct operation of a wide range of equipment, such as injection molding, plastic extrusion and thermoforming machines.

PRODUCT SELECTION

Module Type

Load Monitoring	DRML1
-----------------	-------

POWER SUPPLY SPECIFICATIONS⁽¹⁾

Description	DRML1
Supply Voltage Range	8-30 VDC
Minimum Supply Current	10 mA
Maximum Supply Current	30 mA

INPUT SPECIFICATIONS⁽¹⁾

Description	DRML1
Input Voltage Range	4-32 VDC
Minimum Input Current	100 µA
Maximum Input Current	1.5 mA
Maximum Turn-On Time (Ton)	15 msec
Maximum Turn-Off Time (Toff)	15 msec

EXTERNAL TEACH SPECIFICATIONS⁽¹⁾

Description	DRML1
External Teach Voltage Range	4-32 VDC
Minimum Input Current	100 µA
Maximum Input Current	1.5 mA

CURRENT SENSING SPECIFICATIONS ⁽¹⁾

Description	DRML1
Maximum Teach Current	50 A _{RMS}
Minimum Teach Current	1.2 A _{RMS}
Teach Current	20 Amp Range
	50 Amp Range
Minimum Single Load Current	20 Amp Range
	50 Amp Range
Undercurrent Detection	Teach Current * 0.875 A _{RMS}
Overcurrent Detection	Teach Current * 1.125 A _{RMS}
Load Voltage Frequency Range	47-400 Hz
Load Voltage Range	48-600 VAC
Number of Loads	1 to 8

ALARM SPECIFICATIONS ⁽¹⁾

Description	DRML1
Output Voltage Range	6-29.8 VDC
Output Voltage @ Max. Current (24 VDC supply)	22 VDC
Maximum Output Current ⁽²⁾	100 mA
Minimum Output Current	1mA
Maximum Off-State Leakage Current @ Rated Voltage	1 μA
Maximum Number of Outputs Connected in Parallel ⁽³⁾	128
Alarm Delay Time	0.1 sec
	1 sec
	5 sec
No Mains Voltage/ Open Load Detection Current Min/Max	20 Amp Range
	50 Amp Range

GENERAL SPECIFICATIONS ⁽¹⁾

Description	Parameters
Dielectric Strength, Input to Output (50/60Hz)	4000 V _{RMS}
Minimum Insulation Resistance (@ 500 VDC)	10 ⁹ Ohms
Maximum Capacitance, Input/Output	14 pF
Ambient Operating Temperature Range	-25 to 70 °C
Ambient Storage Temperature Range	-25 to 70 °C
Weight (typical)	1.5 oz (43 g)
Housing Material	UL94 V-0
Humidity	95% non-condensing
LED Input Status Indicator	See Status Chart

THERMAL DERATE INFORMATION

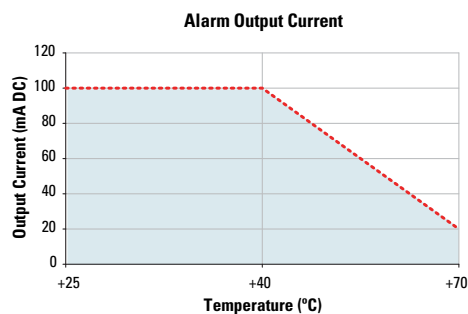

EQUIVALENT CIRCUIT BLOCK DIAGRAMS/WIRING DIAGRAM

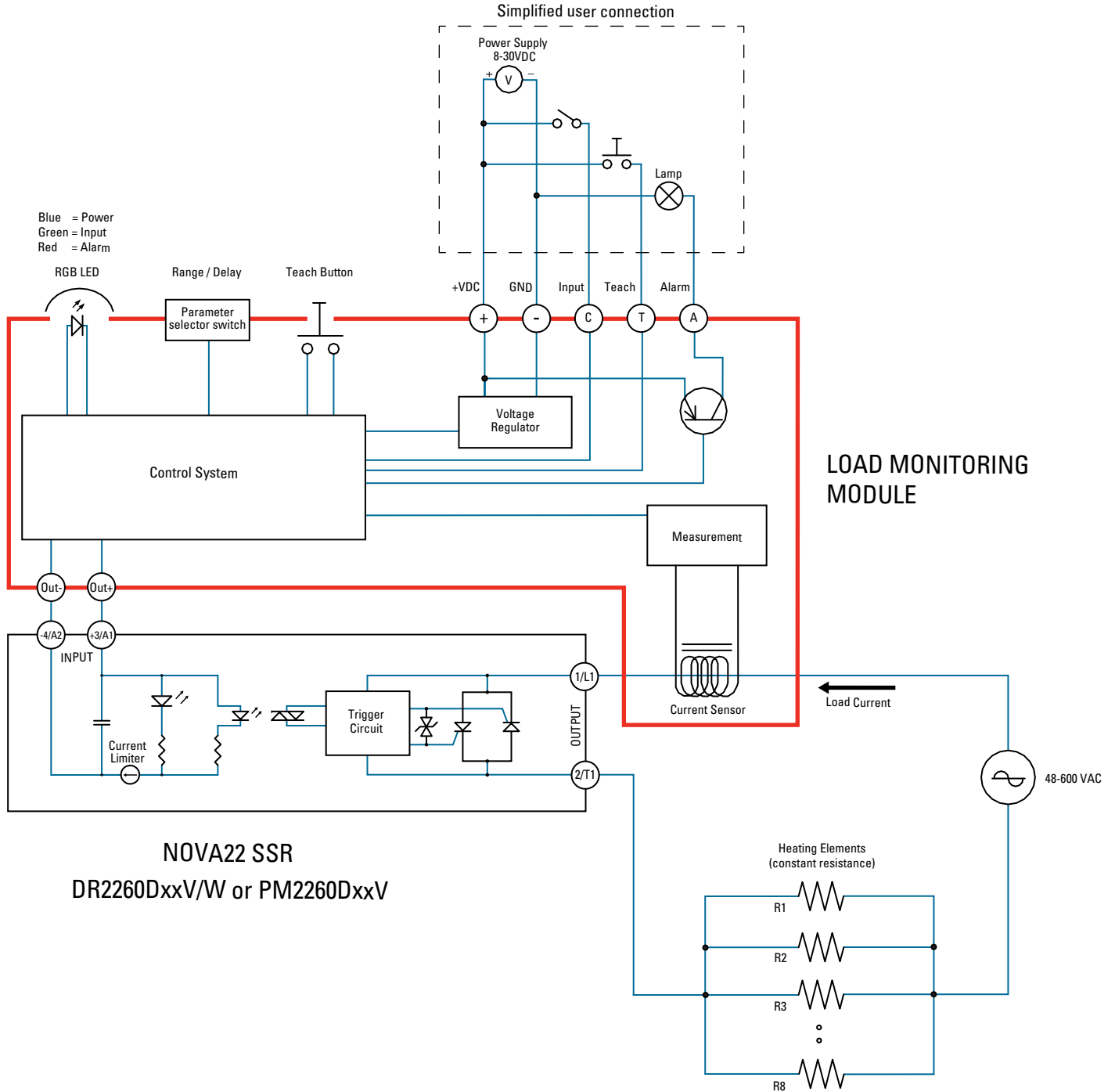

INSTALLATION INSTRUCTIONS

- Remove the ID marker and input connector from the NOVA22 relay.
- Wire input and output as shown in the Wiring Diagram. Before wiring terminal 2/T1 pass the wire through the module hole. For recommended wire sizes and terminal torques see TABLE 1.
- Mount the module onto the relay as shown in steps 1 and 2.
- Proceed to configure the module:
 - ◆ Select the maximum load current (20 Amps or 50 Amps) and the alarm delay (0.1, 1 or 5 secs) using the parameter selector switch. NOTE: Parameter selector switch is updated at startup or if no input signal is present.
 - ◆ Turn on all power supplies.
 - ◆ Press TEACH-IN button (or apply external TEACH-IN input) for 3 seconds to store the nominal load current value. LED will blink Blue 3 times when TEACH process is complete.
 - ◆ Module will start monitoring the system once TEACH-IN button has been released. Refer to TABLE 1 and Status Charts for detailed operation and status.
- For module removal follow steps 3 and 4.

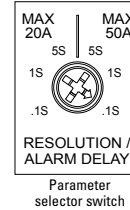

Module Mounting

STEP 1:
Align the module to the bottom of SSR

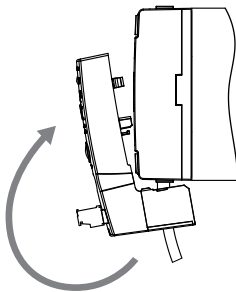

STEP 2:
Push to put into place as shown

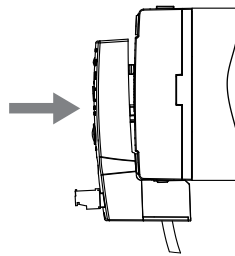

Module Removal

STEP 3:
Loosen screw of terminal 2/T1

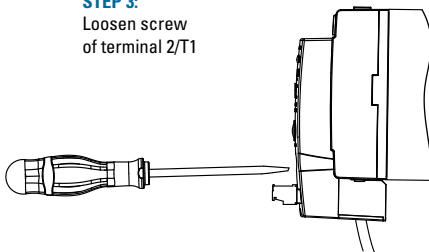

STEP 4:
Hold module and pull to remove

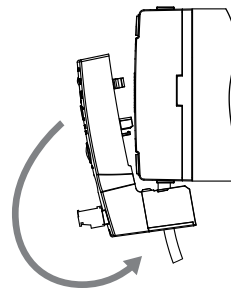

TABLE 1. Recommended Torque and Wire Sizes

Terminal	Max. Screw Torque [in-lb (Nm)]	Wire Size (Solid / Stranded)	Wire Pull-Out Strength (lb)[N]
Output	18-20 (2.0-2.2)	20 AWG (0.75 mm ²) [minimum]	25 [111]
		10 AWG (6 mm ²)	70 [310]
		8 AWG (10 mm ²) [maximum]	70 [310]
Input	1.6 (0.19)	28 AWG (0.09 mm ²) [minimum]	2.2 [9.8]
		14 AWG (2.5 mm ²) [maximum]	22 [98]

STATUS CHARTS

TABLE 2. LED Status

Status	LED Indicator	SSR Output	Alarm Output
No Power	☐ Off	OFF	OFF
Power ON [brand new, no TEACH value]	Blue Blinking constantly	OFF	OFF
Power ON [TEACH value stored]	Blue Blinking 3 times	OFF	OFF
Power ON [TEACH value operative]	Blue	OFF	OFF
Input Control ON	Green	ON	OFF
ALARM - No Mains Voltage/ Open Load	Red	OFF	ON
ALARM - Undercurrent	Blinking Red 1 time	ON	ON
ALARM - Overcurrent	Blinking Red 2 times	ON	ON
ALARM - SSR Short Circuit	Blinking Red constantly	ON	ON

LED Color



Status Chart-Normal Operation

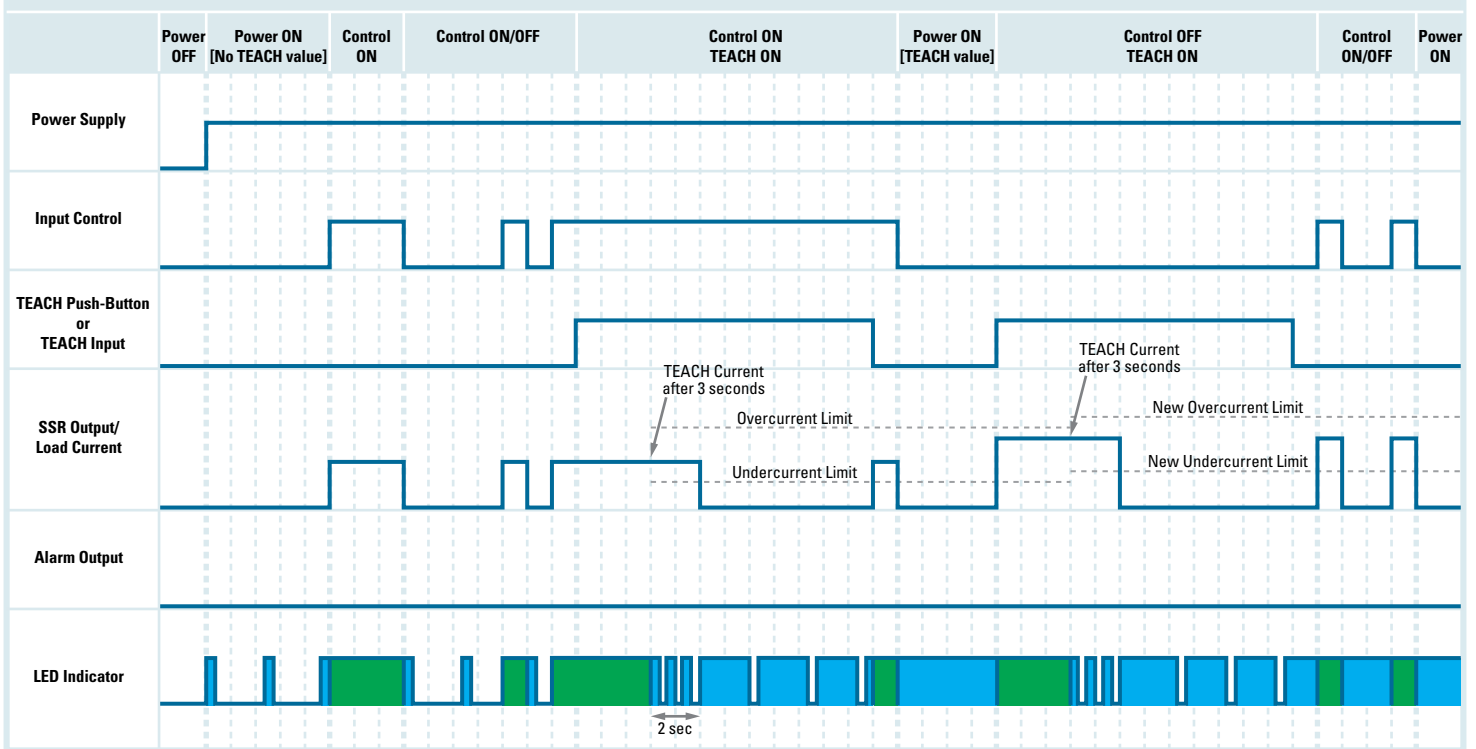

LED Color



Status Chart - Fault Operation

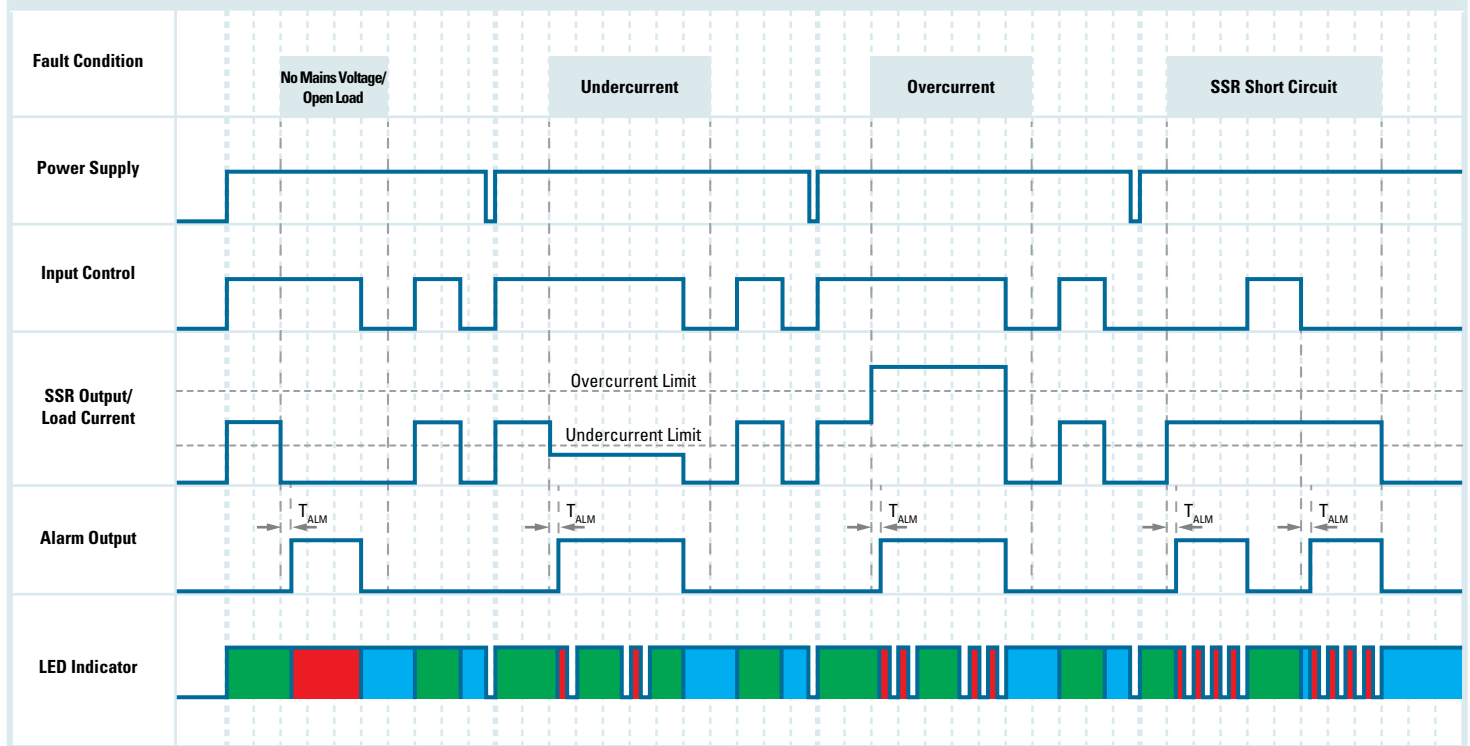

T_{ALM} = Alarm Delay Time

LED Color

Blue Green Red

MECHANICAL SPECIFICATIONS

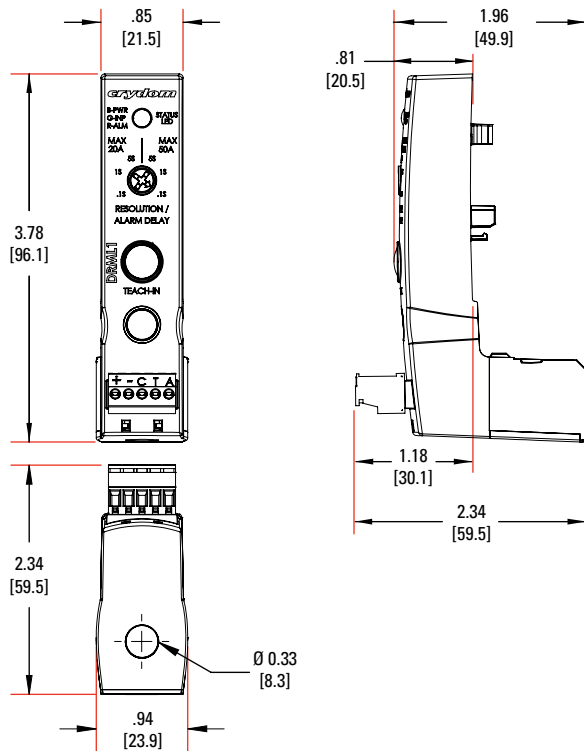

Tolerances: ± 0.02 in / 0.5 mm
All dimensions are in: inches [millimeters]

AGENCY APPROVALS, CONFORMANCES AND EMC

Approvals



Conformances

United States Standard for Industrial Control Equipment - UL 508 and
Canadian Standard Association for Industrial Control Equipment – C22.2 No. 14.

Vibration Resistance IEC 60068-2-6: Amplitude Range 10-55 Hz, Displacement 0.75 mm

Shock Resistance IEC 60068-2-27: Peak Acceleration 15g, Duration 11ms.

Electromagnetic Compatibility

Generic Standard	Immunity Tests	Test Specification Level		Performance
IEC 61000-6-2 Immunity for Industrial Environments	Electrostatic Discharge IEC 61000-4-2	8kV air discharge		Criterion A
		6kV contact discharge		Criterion A
	Fast transients (burst) IEC 61000-4-4	Output	2kV, 5kHz, 100kHz	Criterion B
		Input	1kV, 5kHz, 100kHz	Criterion B
	Surge IEC 61000-4-5	Output	1kV Line to Line	Criterion B
			2kV Line to Earth	Criterion B
		DC	500 VDC Source	Criterion A
		Port	Terminal	

GENERAL NOTES

- (1) All parameters at 25°C unless otherwise specified.
- (2) For ambient temperatures above 40°C see the Alarm Output derate curve.
- (3) With a minimum alarm load current of 10mA (Impedance ≤ 2.4kΩ @ 24 VDC).

⚠ DANGER / PELIGRO / DANGER /GEFAHR / PERICOLO / 危險

<p>HAZARD OF ELECTRIC SHOCK, EXPLOSION, OR ARC FLASH.</p> <ul style="list-style-type: none"> • Disconnect all power before installing or working with this equipment. • Verify all connections and replace all covers before turning on power. <p>Failure to follow these instructions will result in death or serious injury.</p>	<p>RIESGO DE DESCARGA ELECTRICA O EXPLOSION.</p> <ul style="list-style-type: none"> • Desconectar todos los suministros de energia a este equipo antes de trabajar con este equipo. • Verificar todas las conexiones y colocar todas las tapas antes de energizar el equipo. <p>El incumplimiento de estas instrucciones puede provocar la muerte o lesiones serias.</p>	<p>RISQUE DE DESCARGE ELECTRIQUE OU EXPLOSION</p> <ul style="list-style-type: none"> • Eteindre toutes les sources d'énergie de cet appareil avant de travailler dessus de cet appareil • Vérifier tous connections, et remettre tous couverts en place avant de mettre sous <p>De non-suivi de ces instructions provoquera la mort ou des lésions sérieuses.</p>	<p>GEFAHR EINES ELEKTRISCHE N SCHLAGES ODER EINER EXPLOSION.</p> <ul style="list-style-type: none"> • Stellen Sie jeglichen Strom ab, der dieses Gerät versorgt, bevor Sie an dem Gerät Arbeiten durchführen • Vor dem Drehen auf Energie alle Anschlüsse überprüfen und alle Abdeckungen ersetzen. <p>Unterlassung dieser Anweisungen können zum Tode oder zu schweren Verletzungen führen.</p>	<p>RISCHIO DI SCOSSA ELETTRICA O DELL'ESPLOSIONE.</p> <ul style="list-style-type: none"> • Spenga tutta l'alimentazione che fornisce questa apparecchiatura prima di lavorare a questa apparecchiatura • Verificare tutti i collegamenti e sostituire tutte le coperture prima dell'accensione <p>L'omissione di queste istruzioni provocherà la morte o lesioni serie</p>	<p>存在电击、爆炸或电弧闪烁危险</p> <ul style="list-style-type: none"> • 在操作此设备之前请先关闭电源。 <p>若不遵守这些说明,可能会导致严重的人身伤害甚至死亡。</p>
--	--	---	--	--	---

⚠ WARNING / AVERTISSEMENT / WARNUNG /ADVERTENCIA / AVVERTENZA / 警告

<p>RISK OF MATERIAL DAMAGE AND HOT ENCLOSURE</p> <ul style="list-style-type: none"> • The product's side panels may be hot, allow the product to cool before touching. • Follow proper mounting instructions including torque values. • Do not allow liquids or foreign objects to enter this product. <p>Failure to follow these instructions can result in serious injury, or equipment damage.</p>	<p>RISQUE DE DOMMAGE MATERIEL ET DE SURCHAUFFE DU BOITIER</p> <ul style="list-style-type: none"> • Les panneaux latéraux du produit peuvent être chauds. Laisser le produit refroidir avant de le toucher. • Respecter les consignes de montage, et notamment les couples de serrage. • Ne pas laisser pénétrer de liquide ni de corps étrangers à l'intérieur du produit. <p>Le non-respect de cette directive peut entraîner, des lésions corporelles graves ou des dommages matériels.</p>	<p>GEFAHR VON MATERIALSCHÄDEN UND GEHÄUSEERHITZUNG</p> <ul style="list-style-type: none"> • Die Seitenwände können heiß sein. Lassen Sie das Produkt abkühlen, bevor Sie es berühren. • Beachten Sie die Montageanweisungen, • Führen Sie keine Flüssigkeiten oder Fremdkörper in das Produkt ein. <p>Die Nichtbeachtung dieser Anweisung kann Körperverletzung oder Materialschäden zur Folge haben.</p>
<p>RIESGO DE DAÑOS MATERIALES Y DE SOBRECALENTAMIENTO DE LA UNIDAD</p> <ul style="list-style-type: none"> • Los paneles laterales del producto pueden estar calientes. Esperar que el producto se enfríe antes de tocarlo. • Respetar las instrucciones de montaje, y en particular los pares de apretado. • No dejar que penetren líquidos o cuerpos extraños en el producto. <p>Si no se respetan estas precauciones pueden producirse graves lesiones, daños materiales.</p>	<p>RISCHIO DI DANNI MATERIALI E D'INVOLUCRO CALDO</p> <ul style="list-style-type: none"> • I pannelli laterali dell'apparecchio possono scottare; lasciar quindi raffreddare il prodotto prima di toccarlo. • Seguire le istruzioni di montaggio corrette. • Non far entrare liquidi o oggetti estranei in questo apparecchio. <p>La mancata osservanza di questa precauzione può causare gravi rischi per l'incolumità personale o danni alle apparecchiature.</p>	<p>材料损坏和高温外壳的危险性</p> <ul style="list-style-type: none"> • 产品的一侧面板可能很热, 在其冷却前请不要触碰。 • 遵照正确的安装说明, 包括扭矩值。 • 请勿让液体及其他异物进入本产品。 <p>如不能正确执行这些操作说明, 极有可能造成严重人体伤害或者设备的损坏。</p>

ANNEX - ENVIROMENTAL INFORMATION

The environmental information disclosed in this annex including the EIP Pollution logo are in compliance with People’s Republic of China Electronic Industry Standard SJ/T11364 – 2006, Marking for Control of Pollution Caused by Electronic Information Products.

Part Name	Toxic or hazardous Substance and Elements					
	Lead (Pb)	Mercury (Hg)	Cadmium (Cd)	Hexavalent Chromium (Cr (VI))	Polybrominated biphenyls (PBB)	Polybrominated diphenyl ethers (PBDE)
Solder	○	○	○	○	○	○

附件 - 环保信息

此附件所标示的包括电子信息产品污染图标的环保信息符合中华人民共和国电子行业标准 SJ/T11364 - 2006, 电子信息产品污染控制标识要求。

部件名称	有毒有害物质或元素					
	铅 (Pb)	汞 (Hg)	镉 (Cd)	六价铬 (Cr (VI))	多溴联苯 (PBB)	多溴二苯醚 (PBDE)
焊接点	○	○	○	○	○	○

